

60x60x25 mm

12 V



General Specifications

- Material:
 - Frame: Plastics (Flammability: UL 94V-0)
 - Impeller: Plastics (Flammability: UL 94V-1)
- Expected Life: 40,000 h (L10:Survival rate: 90% at 60 °C, rated voltage, and continuously run in a free air state)
- Lead Wire: ⊕ red ⊖ black or blue
- Storage Temperature: -30 °C to +70 °C (Non-condensing)
- Ball bearings
- International Standards: UL/CSA, TÜV, RoHS

Air Flow - Static Pressure Characteristics

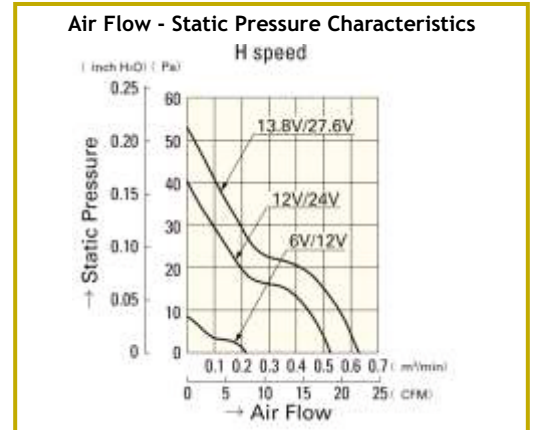

Specifications

Model No.	Rated Voltage [V]	Operating Voltage Range [V]	Rated Current [A]	Rated Input [W]	Rated Speed [min ⁻¹]	Max. Air Flow [m ³ /min] [CFM]	Max. Static Pressure [Pa] [inchH ₂ O]	SPL [dB(A)]	Operating Temperature [°C]	Expected Life [h]
9A0612H402	12	6 to 13.8	0.11	1.32	3,800	0.53 18.7	40.2 0.161	28	-20 to +70	40,000/60°

Dimensions (Unit:mm)

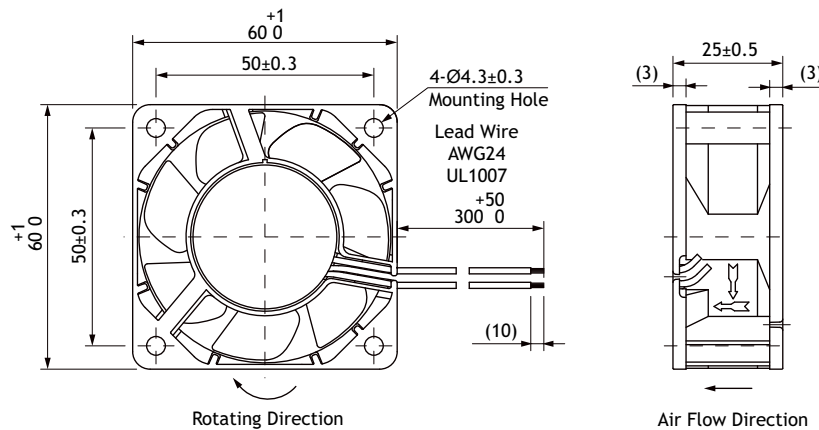

Reference dimension of mounting holes and vent opening (Unit: mm)

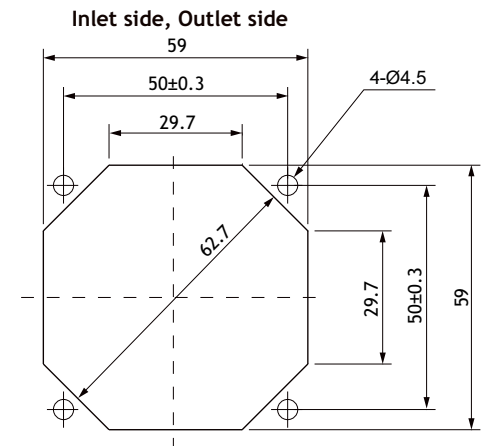

60 mm sq.



- Model always available on stock at R.T.A.
- Also available for online purchasing at www.rta-store.com